



TRACKED EXCAVATOR | JS305 LC

Engine power: 165kW (221hp) Bucket capacity: 1.24 - 1.80m³ Operating weight: 31700 - 32762kg



Easy in a hard world.

In a world of tough working conditions where everything's hard going, the JCB JS305 makes things easy. That's because it's been tailored to your applications, your business, your world. With a simple mechanical fuel injection system that tolerates lower fuel quality and an engine and hydraulics designed to work with productivity in mind. We designed it to be easy to operate, easy to maintain and easy to save money. Quite simply, the JCB JS305 has been designed to move more material for less cost. Your world is hard enough. JCB just made it a whole lot easier.





PRODUCTIVITY. MADE EASY.

FIRST AND FOREMOST, THE NEW JCB JS305 IS DESIGNED TO MOVE HUGE AMOUNTS OF MATERIAL AS QUICKLY AS POSSIBLE. AT ITS HEART IS A FORMIDABLE 7.2-LITRE DIESELMAX ENGINE THAT PRODUCES HUGE AMOUNTS OF POWER AND TORQUE.



Strengthening ribs at idler area provide the force and durability to work in the toughest applications.

The power to excel.

1 The 6-cylinder 7.2-litre JCB DIESELMAX engine fitted to the JS305 produces its peak power (221 hp) and torque (960Nm) at a low 1300rpm. This allows fuel efficient matching of the engine and hydraulics.

2 With a massive 222.6kNm of bucket tearout, fast cycle times are assured in all applications. The intuitive multifunction operation makes simultaneous tracking and excavating smooth and fast.

3 A JCB JS305 provides a solid, stable work platform for fast cycle times.



Innovative design.

The control valve optimises hydraulic oil supply to different functions during combined operation. This multifunctioning prowess helps you to achieve fast cycle times.

Choose from a range of hydraulic pipework options and you'll be able to use your JS305 with a variety of JCB attachments for ultimate versatility.



Simultaneous tracking and excavating is smooth and fast with an intuitive multifunction operation.



For maximum power and productivity, choose the Power+ mode from the rotary controller.

UPTIME. MADE EASY.

WHEN YOU'RE TACKLING TOUGH APPLICATIONS AND DIFFICULT WORKING CONDITIONS, YOU NEED TREMENDOUS RELIABILITY AND DURABILITY. THE NEW JCB JS305 OFFERS EXACTLY THAT; THERE ARE HIGH QUALITY COMPONENTS APLENTY, ALONG WITH SIMPLE AND ROBUST MECHANICAL FUEL INJECTION.

DIESELMAX quality.

1 JCB's DIESELMAX engine has a mechanical in-line Bosch fuel injection system. This rugged premium brand component allows you to work in areas where fuel quality is poor.

The new JS305 benefits from a multi-stage fuel filtration system which protects against a wide range of contaminants as small as two microns.

Made to be better.

2 We use high tensile strength steel to construct the reinforced boom and dipper. Internal baffle plates help to ensure long life durability – likewise heavy-duty wear strips at the dipper end.

3 Advanced manufacturing and assembly processes help to guarantee a very high level of precision and quality in our components.



When it comes to third party components, we select only the very finest, including new Berco running gear, Kawasaki pumps and Kayaba main control valves. All parts for the new JS305 are easily available from your local JCB dealer.



Built to last.

4 With a heavy duty lower frame and upper structure, as well as a high strength boom and arm, this excavator is designed to excel at tough work like quarry applications.

We use finite element analysis with extensive rig and endurance testing to make key components last longer.

The high-strength undercarriage of a JCB JS305 uses a fully-welded X frame construction for long-term durability even in the most demanding applications.

A closed box section revolving frame increases strength and reduces stress. It's also highly resistant to impact damage.

For maximum durability and support, we've made the upper frame as rigid as possible.

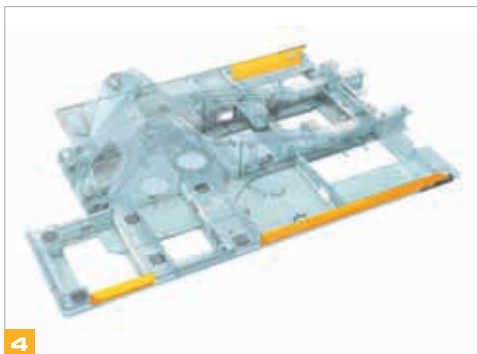

Proper protection.

Grouser plates are a substantial 12mm, offering more protection than the competition.

All major components are intelligently housed inside the upper structure to protect from damage.

A belly guard and boom work light guards are standard, and front cab mesh an option.

5 A mechanical override throttle is located in the cooling pack service bay. Revs can be set to a constant level, ensuring that no matter what happens, the job still gets done.



The JCB JS305 turret is welded to both the upper and lower undercarriage frame.

EFFICIENCY. MADE EASY.

THE JCB JS305 IS DESIGNED TO MOVE MORE MATERIAL FOR LESS. TO ACHIEVE THIS, WE'VE DESIGNED THE ENGINE AND HYDRAULICS TO WORK IN PERFECT HARMONY FOR ULTIMATE EFFICIENCY.

MAX efficiency.

- 1 The new JS305's JCB DIESELMAX engine has an Eco mode which reduces fuel consumption whilst maintaining substantial productivity levels.
- 2 Auto idle reduces engine speed to 1100 rpm after 6 seconds, adjustable up to 30 seconds of machine inactivity. The engine speed is restored as soon as you operate your excavator again.
- 3 Our innovative hydraulic regeneration system recycles oil across the cylinders for faster cycle times and reduced fuel consumption.



Choose Eco mode for precise, efficient excavation and a significant reduction in fuel consumption.



1



2



3 For even more fuel savings, you can use our innovative one-touch idle feature to reduce engine speed at the push of a button.

4 To make oil flow as precise and efficient as possible, we've optimised the hydraulic pump settings and revised the spool configuration within the main valve block. The system now delivers only the flow you need for the job at hand.



CONTROL. MADE EASY.

HERE AT JCB, WE TAKE OPERATOR COMFORT VERY SERIOUSLY, NOT LEAST BECAUSE IT BOOSTS YOUR PRODUCTIVITY. THE NEW JS305 IS THEREFORE A VERY COMFORTABLE AND ERGONOMIC EXCAVATOR, DESIGNED TO KEEP OPERATORS FEELING FRESH AND ALERT FOR LONGER.

A great place to work.

- 1 To minimise noise and vibration, the cab sits on six viscous rubber mounts.
- 2 JCB's climate control option offers a precisely controlled cab temperature with fresh or recirculated air.

- 3 A roomy floor area with large high grip rubber-coated pedals and a rubber footrest is a perfect setup for easy and precise tracking.
- 4 Ventilation is plentiful when you open the standard cab roof hatch and the rear sliding window.



For the ultimate in precise control, the new JS305 excavator has a rotary throttle controller. There are also three work modes to tailor your machine to any application: Eco, Power and Power+.

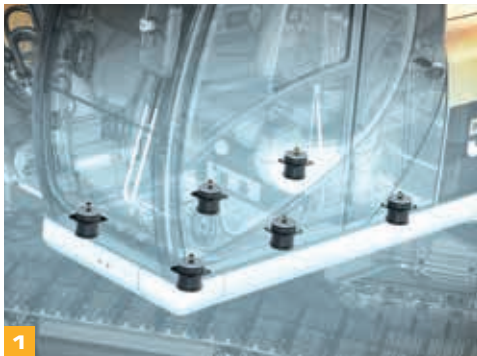

See clearly.

5 A 70/30 front screen split gives the JCB JS305 excellent front visibility. A clear view of the front right track provides easy, safe trench digging and comfortable manoeuvring.

All-round visibility is superb, with a large glass area on the right-hand-side and top corner of the cab. An innovative low-level bonnet allows clear rearward views.

6 Operators are kept abreast of all important information via the 3.5" display. This can be accessed via a new rotary controller.

7 A spacious stowage area behind the seat provides plenty of room for an operators personal items.



SERVICING. MADE EASY.

WE WANTED TO MAKE SURE THAT THE NEW JCB JS305 WAS AS AFFORDABLE, EFFICIENT AND HIGHLY PRODUCTIVE AS POSSIBLE. AS SUCH, WE'VE MADE SURE THAT THIS IS A VERY LOW MAINTENANCE AND EASY-TO-SERVICE EXCAVATOR, HELPING YOU GET THE BEST POSSIBLE SERVICE FROM IT.

Access all areas.

The electrical system on the new JS305 is highly capable yet uncomplicated in design, which improves serviceability and reduces maintenance over the life of your machine.

- 1 To prevent blockages in the cooling pack, we fit a fly-mesh guard. The condenser unit is hinged so it swings out easily, providing access to other coolers for cleaning.
- 2 Because they're mounted side by side on a JCB JS305, the engine radiator, hydraulic cooler and intercooler can be serviced individually yet cleaned easily.
- 3 Fluid filters (engine oil, hydraulic oil and fuel) are centrally located for fast, easy servicing.



By using graphite impregnated bronze bushes, we've reduced the JS305's boom and dipper greasing intervals to 1000 hours for normal applications.

Routine maintenance.

It's easy to keep track of maintenance on this excavator because the in-cab monitor displays useful reminders. You can also track your machine using JCB LiveLink telematics to stay fully abreast of all upcoming maintenance requirements.

All daily check points are accessible from ground level, ensuring easy and safe servicing. The electronic monitoring system, meanwhile, automatically checks engine oil and engine coolant levels on machine start-up.

With the optional auto lubrication kit, your machine will take care of its own greasing requirements.

Engine oil and filter changes are only required every 500 hours; hydraulic oil change intervals are 5000 hours; while hydraulic filters need to be changed every 1000 hours. All in all, we give you the maximum uptime by minimising maintenance time.

Maximum uptime.

The Powercore air filter combines with a cyclonic engine fan scavenge system to give double the filtering capacity of a standard air filter. This is a longer life system with fewer components, offering higher efficiency. The end result for you? Far greater engine protection.

JCB JS305 bonnets open and close easily with gas-assisted cylinders, and the service bays are large and wide for good access.

There's a large 590-litre fuel tank to allow as many operating hours as possible between refills.



SAFETY. MADE EASY.

WE UNDERSTAND HOW IMPORTANT IT IS THAT YOU PROTECT OPERATORS, MACHINERY AND BYSTANDERS ALIKE ON SITE. THAT'S WHY YOU'LL FIND WE'VE EQUIPPED THE NEW JCB JS305 WITH EXCELLENT VISIBILITY TO ALL CORNERS, NON-SLIP SURFACES WHERE YOU NEED THEM, AND SAFE SERVICE ACCESS. AND THAT'S JUST THE START.



Visibly better.

- 1** A large glass area and low bonnet line afford superb visibility.
- 2** This excavator is equipped with a full set of side and rear view mirrors for all round visibility and safety compliance.
- 3** With six work lights, you can rely on superb all-round visibility even in low-light conditions.
- 4** JCB's optional rear view camera displays an uninterrupted rearward view for improved operator confidence whilst slewing.



Well protected.

6 The bonnet opens front-to-rear for easy and safe engine service access.

6 JCB's Safety Level Lock fully isolates hydraulic functions to avoid unintended movements. Our 2GO system means a new JCB JS305 can only be started in a safe locked position via two separate inputs.

7 You'll find that the steps and platforms have anti-slip punched steel plates for optimum grip. Bolt-on plates have recessed bolts to reduce trip hazards.

To prevent engine damage in arduous conditions, we fit an engine overheat safety system as standard.

8 LiveLink telematics are fitted as standard too. This innovative JCB feature helps you to maximise security and fleet utilisation, and also allows you to monitor useful information like fuel usage on different shifts.



SUPPORT. MADE EASY.

LIVELINK IS AN INNOVATIVE SOFTWARE SYSTEM THAT LETS YOU MANAGE JCB MACHINES REMOTELY – ONLINE, BY EMAIL OR BY MOBILE PHONE. ACCESS EVERYTHING FROM MACHINE ALERTS TO PERFORMANCE REPORTS AND HISTORY INFORMATION, WITH ALL DATA STORED AT A SECURE CENTRE.

Productivity and cost benefits

By providing information like idle time monitoring and machine performance, JCB LiveLink helps reduce your fuel usage, saving money and improving productivity. Machine location information can help improve efficiency and perhaps even reduce insurance costs.

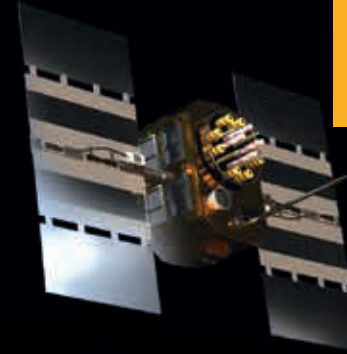
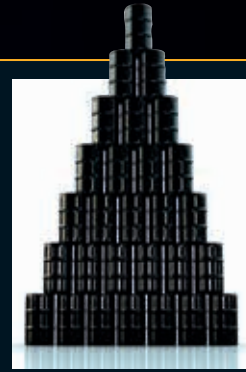

Maintenance benefits

Manage machine maintenance easily – accurate hours monitoring and service alerts improve maintenance planning, while real-time location data helps you manage your fleet. Critical machine alerts and maintenance history records are also available.



Security benefits

LiveLink's real-time geofencing alerts tell you when machines move out of predetermined zones, and real-time curfew alerts inform you of unauthorised usage. Further benefits include real-time location information.



SUPPORT. MADE EASY.

JCB'S WORLDWIDE CUSTOMER SUPPORT IS FIRST CLASS. WHATEVER YOU NEED AND WHEREVER YOU ARE, WE'LL BE AVAILABLE QUICKLY AND EFFICIENTLY TO HELP MAKE SURE YOUR MACHINERY IS PERFORMING TO ITS FULL POTENTIAL.



1

1 Our Technical Support Service provides instant access to factory expertise, day or night, while our Finance and Insurance teams are always on hand to provide fast, flexible, competitive quotes.

2 The global network of JCB Parts Centres is another model of efficiency; with 16 regional bases, we can deliver around 95% of all parts anywhere in the world within 24 hours. Our genuine JCB parts are designed to work in perfect harmony with your machine for optimum performance and productivity.



2

3 JCB Assetcare offers comprehensive extended warranties and service agreements, as well as service-only or repair and maintenance contracts. Irrespective of what you opt for, our maintenance teams around the world charge competitive labour rates, and offer non-obligation quotations as well as fast, efficient insurance repair work.



3

Note: JCB LIVELINK and JCB ASSETCARE may not be available in your region, so please check with your local dealer.

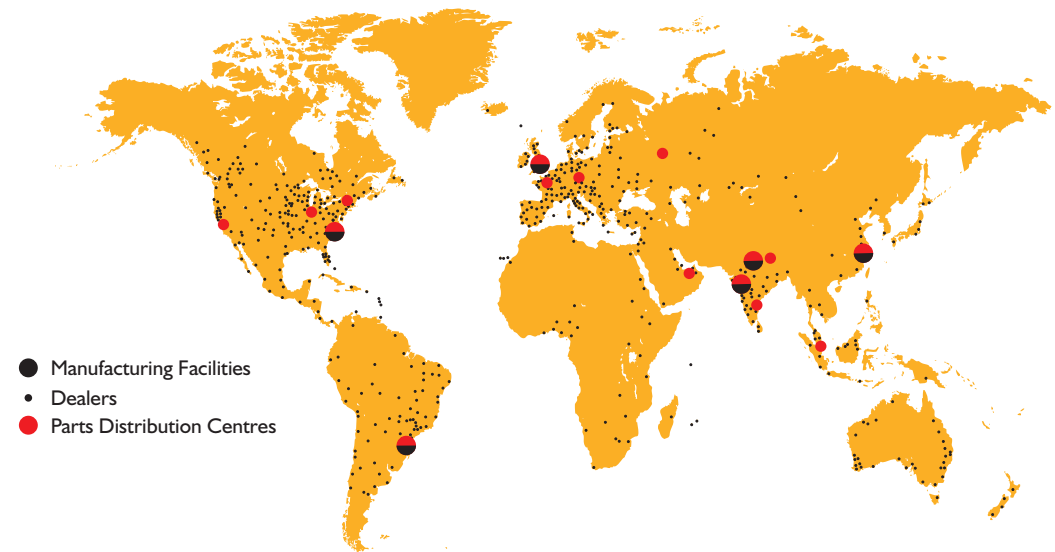

STATIC DIMENSIONS

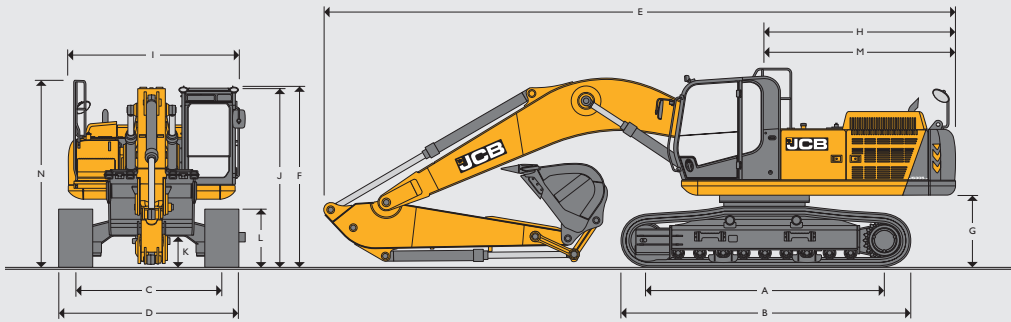

STATIC DIMENSIONS

Model	LC	
A Track length on ground	mm	3990
B Undercarriage overall length	mm	4954
C Track gauge	mm	2600
D Width over tracks (600mm trackshoes)	mm	3200
D Width over tracks (700mm trackshoes)	mm	3300
D Width over tracks (800mm trackshoes)	mm	3400
D Width over tracks (900mm trackshoes)	mm	3500
G Counterweight clearance	mm	1223
H Tail swing radius	mm	3213
I Overall width of superstructure	mm	3067
J Height over cab	mm	3331
K Ground clearance	mm	550
L Track height	mm	1026
M Tail length	mm	3185
N Height over grab rail	mm	3374
Monoboomb 6.2m		
Dipper lengths	2.5m	3.1m
E Transport length	mm	10755
F Transport height	mm	3459

ENGINE

Model	JCB DIESELMAX 672 mechanical engine
Type	Water cooled, 4-stroke, 6-cylinder in line, mechanical direct injection, turbocharged, intercooled.
Rated power	165kW (221 hp) at 1800rpm
Piston displacement	7.2 litres.
Air filtration	Dry element with secondary safety element & in-cab warning indicator.
Starting system	24 volt.
Batteries	2 x 12 volt.
Alternator	24 volt, 55 ampere.

SLEW SYSTEM

Slew motor	Axial piston type.
Slew brake	Negative type, oil lubricated, multi-disc parking brake.
Slew torque	100.3 kNm
Slew speed	9.4 rpm
Slew gear	Large diameter, internally toothed fully sealed grease bath lubricated.

UNDERCARRIAGE

Carriage options	LC - Long Carriage.
Construction	Fully welded 'X' frame type with central belly guarding and sloping sidemembers with dirt relief holes under top rollers.
Recovery point	Front and rear.
Track shoe options	600mm 700mm 800mm 900mm
Upper and lower rollers	Heat treated, sealed and lubricated.
Track adjustment	Grease cylinder type.
Track idler	Sealed and lubricated, with spring cushioned recoil.
Track type	Sealed and lubricated.
Rollers and shoes (each side)	LC
No. of track guides	2 per side
No. of lower rollers	9 per side
No. of upper rollers	2 per side
No. of track shoes	50 per side

TRACK DRIVE	
Type	Fully hydrostatic, two speed with autoshift.
Travel motors	Variable swash axial piston type, fully guarded within undercarriage.
Final drive	Planetary reduction, bolt-on sprockets.
Service brake	Hydraulic counter balance valve.
Park brake	Disc type, spring applied, automatic hydraulic release.
Gradeability	70% (35 deg) continuous.
Travel speed	High – 5.2 km/h Low – 2.1 km/h
Tractive effort	246.3 kNm

HYDRAULIC SYSTEM	
Open centered, negative control hydraulic system with twin variable flow piston pumps providing flow-on-demand.	
Pumps	
Main pumps	2 variable displacement axial piston type.
Maximum flow	2 x 250 l/min.
Servo pump	Gear type.
Maximum flow	18 l/min.
Control valve	
A combined four and five spool control valve with auxiliary service spool as standard.	
Relief valve settings	
Boom/Arm/Bucket	343 bar MRV (392 bar ARV).
Swing circuit	290 bar.
Travel circuit	343 bar.
Pilot control	39 bar.
Filtration	
In tank	195 micron, suction strainer.
Main return line	10 micron.
Pilot line	10 micron.
Hydraulic hammer return	10 micron, aluminium housing with perbunan (NBR) seals.

SERVICE CAPACITIES			
Fuel tank	Litres		590
Engine coolant	Litres		32
Engine oil	Litres		30
Swing reduction gear	Litres		16
Track reduction gear (each side)	Litres		5
Hydraulic system	Litres		430
Hydraulic tank*	Litres		239

*Deduction cylinder volumes and service fill (25 litres).

WEIGHTS AND GROUND BEARING PRESSURES					
Figures include 1.49m ³ (1364kg) bucket, 80kg operator, full fuel tank and 2.5m dipper.					
		600mm shoes	700mm shoes	800mm shoes	900mm shoes
Machine weight	kg	31700	32054	32408	32762
Ground bearing pressure	kg/cm ²	0.66	0.57	0.51	0.46

BUCKET AND ARM COMBINATION					
Bucket width	mm	1360	1570	1660	1825
Bucket capacity	m ³	1.24	1.49	1.61	1.80
Bucket weight	kg	1259	1364	1449	1532
LC					
2.5m Quickhitch (No Quickhitch)	m	□ (□)	□ (□)	■ (□)	■ (□)
3.1m Quickhitch (No Quickhitch)	m	□ (□)	■ (□)	■ (□)	● (■)

- = Suitable for general excavating (materials up to 1800kg/m³)
- = Suitable for light excavating (materials up to 1500kg/m³)
- = Suitable for grading and loading (materials up to 1200kg/m³)

STANDARD / OPTIONAL EQUIPMENT		
	Standard	Optional
Alarm	-	Travel alarm
Arm	2.5m Heavy duty arm	3.1m Heavy duty arm
Beacon	-	Warning beacon
Breaker	-	HM270T (includesmoil & chisel)
Belly plate	6mm plate (undercarriage & revolving frame)	10mm plate (undercarriage & revolving frame)
Buckets	1.61m ³ HD	1.24m ³ HD, 1.49m ³ HD, 1.80m ³ HD
Camera	-	Rear-view camera with monitor
Climate control	Standard climate control	Carbon filter
Fire extinguisher	-	Fire extinguisher kit
Hydraulic oil	Hydraulic oil HP46	Hydraulic oil HP32, Hydraulic oil HP68
Lifting hook	-	Lifting hook on tipping link (hook or eye)
Lights	6 x Standard halogen worklights	Worklight guards
Pipework options	-	Hammer pipework Open/close pipework (high flow double acting) Rotate pipework (low flow double acting) Merged high flow (double acting)
Quickhitch	-	Hydraulic quick hitch & installation kit
Track guides	Twin track guides	Full length track guides
Trackshoes	12mm Standard duty 600mm 700mm 800mm 900mm	15mm Heavy duty 600mm 700mm



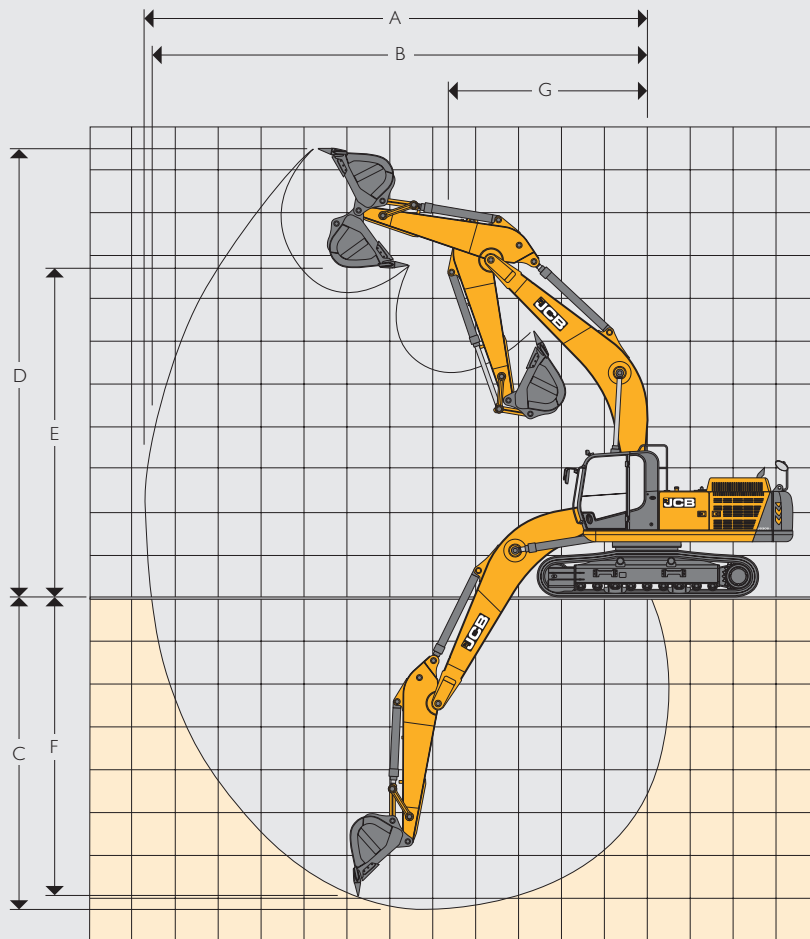







WORKING RANGE MONOBOOM 6.2M



WORKING RANGE MONOBOOM 6.2M

Dipper length		2.5m	3.1m	
A	Maximum digging reach	mm	10158	10686
B	Maximum digging reach (on ground)	mm	9933	10473
C	Maximum digging depth	mm	6499	7090
D	Maximum digging height	mm	9935	10289
E	Maximum dumping height	mm	7238	7516
F	Maximum vertical wall cut depth	mm	6133	6628
G	Minimum swing radius	mm	4181	4136
	Bucket rotation	deg	185°	185°
	Maximum dipper tearout	kNm	156.4	129.0
	Maximum bucket tearout	kNm	222.6	222.6

LIFT CAPACITIES – Dipper length: 2.5m, Boom: 6.2m, 600mm Trackshoes, No bucket. JS305 LC MONO

Load Point	Reach from Swing Centre										
	3.0m		4.5m		6.0m		7.5m		Capacity at Maximum Reach		
											
Height	kg	kg	kg	kg	kg	kg	kg	kg	kg	kg	mm
6m					7460*	7460*	7170*	5430	7170*	5340	7565
4.5m			10700*	10700*	8470*	7540	7480*	5280	7290	4540	8190
3m			13600*	10590	9760*	7030	8080*	5040	6720	4130	8501
1.5m					10880*	6610	7950	4820	6540	3980	8533
0m			15830*	9630	10900	6370	7790	4670	6740	4070	8291
- 1.5m	13440*	13440*	15320*	9650	10830	6300	7760	4650	7420	4460	7748
- 3m	18820*	18820*	13940*	9840	10520*	6410			8910	5400	6830

LIFT CAPACITIES – Dipper length: 3.1m, Boom: 6.2m, 600mm Trackshoes, No bucket. JS305 LC MONO

Load Point	Reach from Swing Centre										
	3.0m		4.5m		6.0m		7.5m		Capacity at Maximum Reach		
											
Height	kg	kg	kg	kg	kg	kg	kg	kg	kg	kg	mm
6m					6680*	6680*	6460*	5550	5290*	4690	8210
4.5m			9450*	9450*	7740*	7700	6920*	5360	5340*	4050	8787
3m			12380*	10980	9120*	7160	7610*	5090	5570*	3710	9077
1.5m			14690*	10060	10400*	6680	7980	4830	5910	3580	9108
0m			15670*	9640	10920	6370	7770	4640	6050	3640	8882
- 1.5m	12510*	12510*	15600*	9550	10760	6240	7670	4560	6550	3920	8378
- 3m	19540*	19540*	14640*	9660	10810	6270	7750	4630	7690	4590	7540



Lift capacity front and rear.



Lift capacity full circle.

Notes:

1. Lifting capacities are based on ISO 10567, that is: 75% of minimum tipping load or 87% of hydraulic lift capacity, whichever is the less. Lifting capacities marked* are based on hydraulic capacity.
2. Lift capacities assume that the machine is on firm, level ground.
3. Lift capacities may be limited by local regulations. Please refer to your dealer.







ONE COMPANY, OVER 300 MACHINES.

Your nearest JCB dealer

Tracked Excavator JS305 LC

Engine power: 165kW (221hp) Bucket capacity: 1.24 - 1.80m³ Operating weight: 31700 - 32762kg

JCB Sales Limited, Rokester, Staffordshire, United Kingdom ST14 5JP.

Tel: +44 (0)1889 590312 Email: salesinfo@jcb.com

Download the very latest information on this product range at: www.jcb.com

©2016 JCB Sales. All rights reserved. No part of this publication may be reproduced, stored in a retrieval system, or transmitted in any form or by any other means, electronic, mechanical, photocopying or otherwise, without prior permission from JCB Sales. All references in this publication to operating weights, sizes, capacities and other performance measurements are provided for guidance only and may vary dependant upon the exact specification of machine. They should not therefore be relied upon in relation to suitability for a particular application. Guidance and advice should always be sought from your JCB Dealer. JCB reserves the right to change specifications without notice. Illustrations and specifications shown may include optional equipment and accessories. All images are correct at time of print. The JCB logo is a registered trademark of J C Bamford Excavators Ltd.

